

# User Manual

## BG1000 Series Barrier Gate

Date: May 2021

Doc Version: 1.0

English

Thank you for choosing our product. Please read the instructions carefully before operation. Follow these instructions to ensure that the product is functioning properly. The images shown in this manual are for illustrative purposes only.



For further details, please visit our Company's website  
[www.zkteco.com](http://www.zkteco.com).

Copyright © 2021 ZKTECO CO., LTD. All rights reserved.

Without the prior written consent of ZKTeco, no portion of this manual can be copied or forwarded in any way or form. All parts of this manual belong to ZKTeco and its subsidiaries (hereinafter the "Company" or "ZKTeco").

## Trademark

**ZKTeco** is a registered trademark of ZKTeco. Other trademarks involved in this manual are owned by their respective owners.

## Disclaimer

This manual contains information on the operation and maintenance of the ZKTeco equipment. The copyright in all the documents, drawings, etc. in relation to the ZKTeco supplied equipment vests in and is the property of ZKTeco. The contents hereof should not be used or shared by the receiver with any third party without the express written permission of ZKTeco.

The contents of this manual must be read as a whole before starting the operation and maintenance of the supplied equipment. If any of the content(s) of the manual seems unclear or incomplete, please contact ZKTeco before starting the operation and maintenance of the said equipment.

It is an essential pre-requisite for the satisfactory operation and maintenance that the operating and maintenance personnel are fully familiar with the design and that the said personnel have received thorough training in operating and maintaining the machine/unit/equipment. It is further essential for the safe operation of the machine/unit/equipment that personnel has read, understood and followed the safety instructions contained in the manual.

In case of any conflict between terms and conditions of this manual and the contract specifications, drawings, instruction sheets or any other contract-related documents, the contract conditions/documents shall prevail. The contract specific conditions/documents shall apply in priority.

ZKTeco offers no warranty, guarantee or representation regarding the completeness of any information contained in this manual or any of the amendments made thereto. ZKTeco does not extend the warranty of any kind, including, without limitation, any warranty of design, merchantability or fitness for a particular purpose.

ZKTeco does not assume responsibility for any errors or omissions in the information or documents which are referenced by or linked to this manual. The entire risk as to the results and performance obtained from using the information is assumed by the user.

ZKTeco in no event shall be liable to the user or any third party for any incidental, consequential, indirect, special, or exemplary damages, including, without limitation, loss of business, loss of profits, business interruption, loss of business information or any pecuniary loss, arising out of, in connection with, or relating to the use of the information contained in or referenced by this manual, even if ZKTeco has been advised of the possibility of such damages.

This manual and the information contained therein may include technical, other inaccuracies or typographical errors. ZKTeco periodically changes the information herein which will be incorporated into new additions/amendments to the manual. ZKTeco reserves the right to add, delete, amend or modify the information contained in the manual from time to time in the form of circulars, letters, notes, etc. for better operation and safety of the machine/unit/equipment. The said additions or amendments are meant for improvement /better operations of the machine/unit/equipment and such amendments shall not give any right to claim any compensation or damages under any circumstances.

ZKTeco shall in no way be responsible (i) in case the machine/unit/equipment malfunctions due to any non-compliance of the instructions contained in this manual (ii) in case of operation of the machine/unit/equipment beyond the rate limits (iii) in case of operation of the machine and equipment in conditions different from the prescribed conditions of the manual.

The product will be updated from time to time without prior notice. The latest operation procedures and relevant documents are available on <http://www.zkteco.com>.

If there is any issue related to the product, please contact us.

## ZKTeco Headquarters

**Address** ZKTeco Industrial Park, No. 32, Industrial Road,  
Tangxia Town, Dongguan, China.

**Phone** +86 769 - 82109991

**Fax** +86 755 - 89602394

For business-related queries, please write to us at [sales@zkteco.com](mailto:sales@zkteco.com).

To know more about our global branches, visit [www.zkteco.com](http://www.zkteco.com).

## About the Company

ZKTeco is one of the world's largest manufacturer of RFID and Biometric (Fingerprint, Facial, Finger-vein) readers. Product offerings include Access Control readers and panels, Near & Far-range Facial Recognition Cameras, Elevator/floor access controllers, Turnstiles, License Plate Recognition (LPR) gate controllers and Consumer products including battery-operated fingerprint and face-reader Door Locks. Our security solutions are multi-lingual and localized in over 18 different languages. At the ZKTeco state-of-the-art 700,000 square foot ISO9001-certified manufacturing facility, we control manufacturing, product design, component assembly, and logistics/shipping, all under one roof.

The founders of ZKTeco have been determined for independent research and development of biometric verification procedures and the productization of biometric verification SDK, which was initially widely applied in PC security and identity authentication fields. With the continuous enhancement of the development and plenty of market applications, the team has gradually constructed an identity authentication ecosystem and smart security ecosystem, which are based on biometric verification techniques. With years of experience in the industrialization of biometric verifications, ZKTeco was officially established in 2007 and now has been one of the globally leading enterprises in the biometric verification industry owning various patents and being selected as the National High-tech Enterprise for 6 consecutive years. Its products are protected by intellectual property rights.

## About the Manual

This manual introduces the operations of BG1000 Series Barrier Gate.

All figures displayed are for illustration purposes only. Figures in this manual may not be exactly consistent with the actual products.





## Document Conventions

Conventions used in this manual are listed below:

### GUI Conventions

For Device	
Convention	Description
< >	Button or key names for devices. For example, press <OK>.
[ ]	Window names, menu items, data table, and field names are inside square brackets. For example, pop up the [New User] window.
/	Multi-level menus are separated by forwarding slashes. For example, [File/Create/Folder].

### Symbols

Convention	Description
	This implies about the notice or pays attention to, in the manual.
	The general information which helps in performing the operations faster.
	The information which is significant.
	Care taken to avoid danger or mistakes.
	The statement or event that warns of something or that serves as a cautionary example.

## Table of Contents

<b>1</b>	<b>OVERVIEW</b> .....	<b>7</b>
<b>2</b>	<b>FEATURES AND FUNCTIONALITIES</b> .....	<b>7</b>
<b>3</b>	<b>APPEARANCE AND DIMENSIONS</b> .....	<b>8</b>
<b>4</b>	<b>SPECIFICATIONS</b> .....	<b>9</b>
<b>5</b>	<b>INSTALLATION PROCEDURE</b> .....	<b>10</b>
5.1	INSTALLATION PRECAUTIONS .....	10
5.2	CABLE EMBEDDING .....	10
5.3	BOOM INSTALLATION .....	12
5.3.1	BOOM INSTALLATION PROCEDURE .....	12
<b>6</b>	<b>LEFT AND RIGHT DIRECTIONS</b> .....	<b>13</b>
<b>7</b>	<b>MAINBOARD WIRING INSTRUCTIONS</b> .....	<b>13</b>
7.1	CONNECTION WITH LPR CAMERA .....	14
7.2	CONNECTION WITH UHF CONTROLLER.....	15
7.3	CONNECTION WITH LOOP DETECTOR .....	15
7.4	CONNECTION WITH VR10 RADAR SENSOR.....	16
7.5	CONNECTION WITH INFRARED/PHOTOCELL DETECTOR.....	17
<b>8</b>	<b>FUNCTIONAL PARAMETER SETTINGS</b> .....	<b>19</b>
8.1	MAINBOARD PARAMETER SETTINGS .....	19
8.1.1	OPERATING PROCEDURE.....	19
8.2	PARAMETER SETTINGS DESCRIPTION .....	20
8.3	REMOTE CONTROL PAIRING AND UNPAIRING .....	21
8.4	SET DELAY FOR AUTOMATIC CLOSING AFTER OPENING THE BOOM.....	22
<b>9</b>	<b>BOOM BARRIER ADJUSTMENTS</b> .....	<b>23</b>
9.1	DIMENSIONS.....	23
9.2	HORIZONTAL AND VERTICAL ANGLE ADJUSTMENT OF BARRIER BOOM (MECHANICAL ADJUSTMENT).....	23
9.3	DIRECTION INTERCHANGE OF THE BARRIER BOOM.....	25
9.4	SPRING ADJUSTMENT .....	30
<b>10</b>	<b>PRODUCT PACKING LIST</b> .....	<b>31</b>
<b>11</b>	<b>TROUBLESHOOTING</b> .....	<b>32</b>

**12 SAFETY PRECAUTIONS ..... 33**

**13 TRANSPORTATION AND STORAGE ..... 33**

**14 WARRANTY ..... 33**

## 1 Overview

BG1000 series barrier gate is a high-performance barrier gate that adopts ZKTeco' s interactive LED chassis design. It controls the flow of the traffic in and out of the premises providing maximum security at a low cost. It adopts ARM7 embedded system control core, brushless DC motor, and SCM421 material gear transmission structure to offer maximum efficiency.

It has the advantages of high speed, efficiency, stable quality, user-friendly customization, comprehensive performance, and so on. It can be used in real-time application areas such as offices, hospitals, public places, residential areas to ease traffic issues.

## 2 Features and Functionalities

- The operating speed is 1.5s, and the speed can be adjusted according to different boom arm lengths.
- Reversible left and right directions.
- The transmission mechanism is simple, compact, and easy to install on-site.
- Interactive and stylish chassis LED design.
- Equipped with digital control monitoring, thus supports delay in automatic close, automatic test, rise/fall output status display.
- Supports automatic power-off, manual rise of the boom arm, anti-smash, and fire linkage functions.
- The angle of rise/fall of the arm can be adjusted, and the digital encoder is adopted to limit the position automatically, thus replacing the traditional limiting procedure. The position control is accurate.
- 24V backup battery can be used to ensure the normal operation of the barrier when power is off.
- The chassis is made of a 2.0mm metal sheet through an electrophoretic and powder spraying process.
- The boom will bounce back when it is blocked.



### 3 Appearance and Dimensions

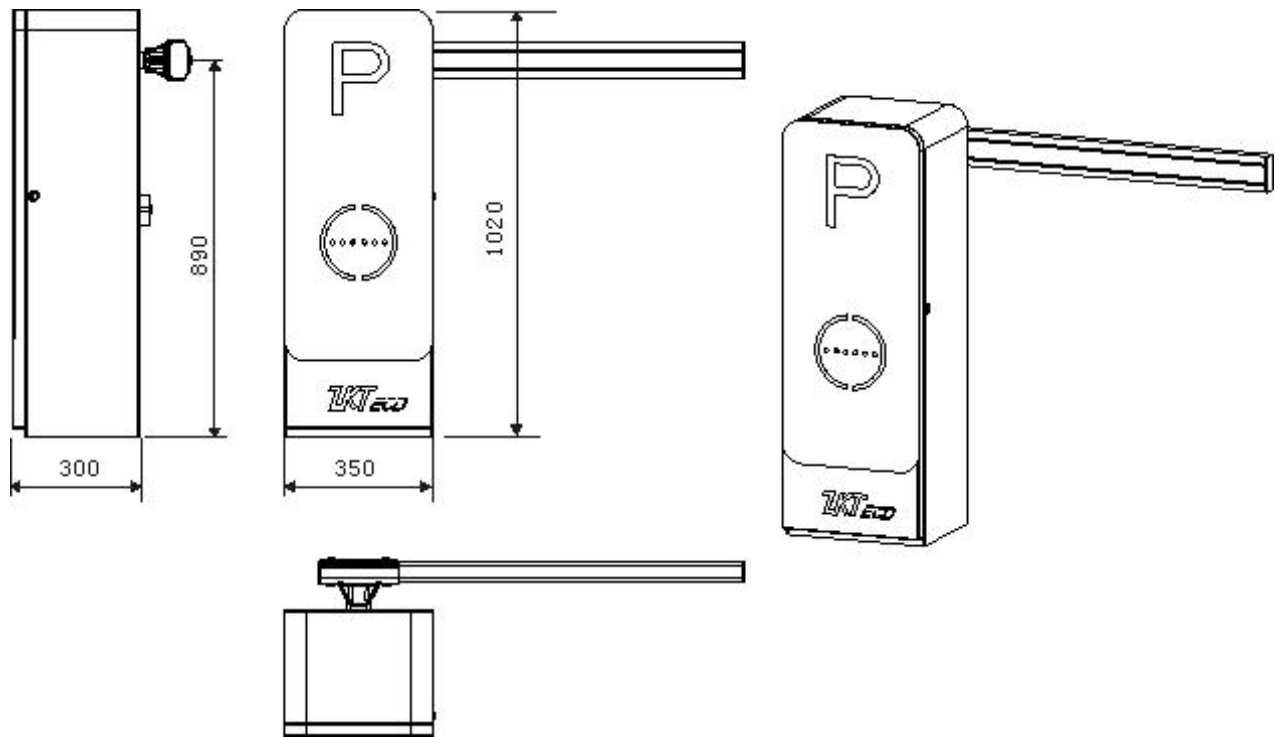
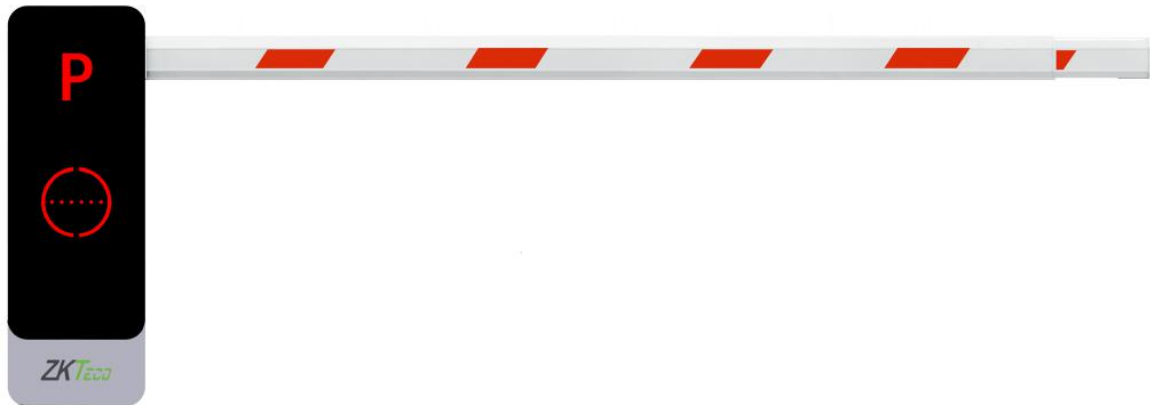

## 4 Specifications

Model/Feature	BG1030L/R	BG1045L/R	BG1060L/R	BG1045L/ R-LED	BG1145L/ R-90
<b>Opening/Closing Speed</b>	1.5s	2.5s	5s	2.5s	2.5s
<b>Boom Length</b>	3m	4.5m	6m	4.5m	4.5m
<b>Spring Size</b>	Φ 4.5mm	Φ 5.5mm	Φ 6.5mm	Φ 5.5mm	Φ 5.5mm
<b>Boom Type</b>	Telescopic straight boom			Straight boom with LED	Folding boom
<b>Chassis Dimensions</b>	350mm*300mm*1020mm				
<b>Chassis Weight</b>	45kg				
<b>Motor Type</b>	24V DC brushless motor				
<b>Output Power</b>	120W				
<b>Rated Current</b>	6A				
<b>Power Supply</b>	220V AC 50Hz/110V AC 60Hz				
<b>Operating Temperature</b>	-35°C to 70°C				
<b>Operating Humidity</b>	<90%				
<b>MCBF</b>	3 Million times				
<b>Remote Control Distance</b>	≥30m				

## 5 Installation Procedure

### 5.1 Installation Precautions

1. Install the parking barrier on a flattened ground. A cement foundation is required before installation if the ground is not solid and flat.
2. It is possible to reduce the length of the boom, but it cannot be increased. After the boom has been cut, it is important to set the spring balance again to achieve a new balance. The bottom of the spring contains two plastic nuts designed to adjust the new balance.
3. When powered on, do not change the wire connection inside.
4. Connect the GND to the cabinet for ensured protection.

### 5.2 Cable Embedding

1. A  $\phi 25$  protective sleeve and a cable are required.
2. The route cables must pass through the protective sleeves.
3. Use a tool to open the cable tray on the ground.

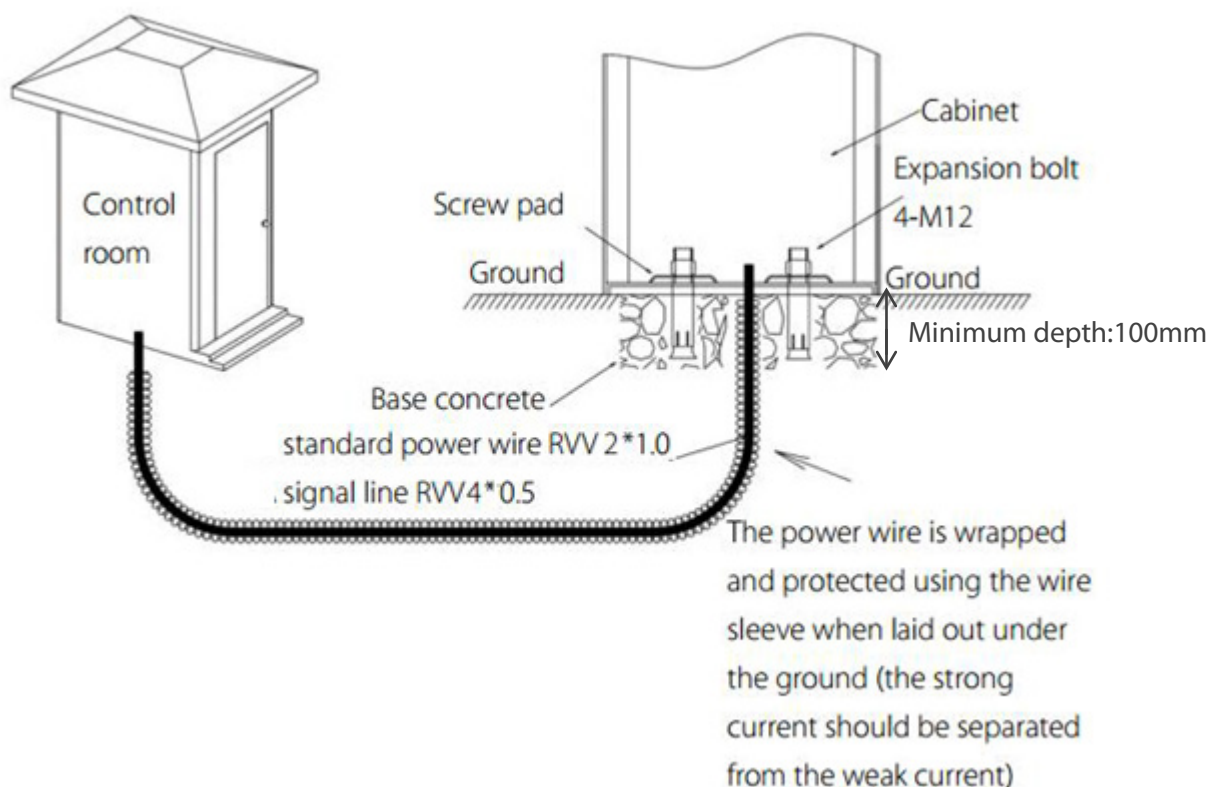

### Dimensions

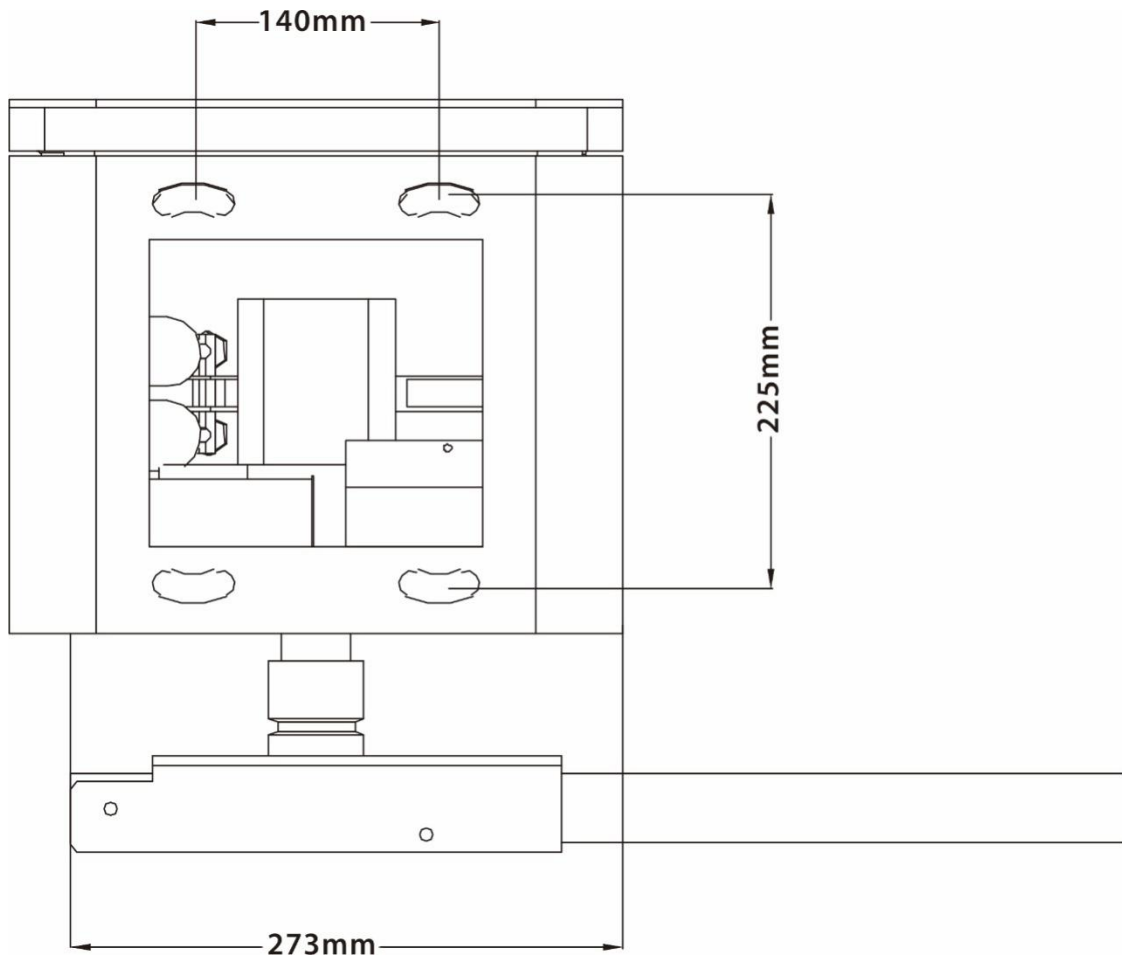

## 5.3 Boom Installation

### 5.3.1 Boom Installation Procedure

1. Pull the secondary boom out from the upper boom, and then fasten with 2 screws, as shown in Figure 1.
2. The procedure of installing the boom to the chassis is shown in Figure 2.



Figure 1 Connect the main boom with the Secondary arm together by 2 screws

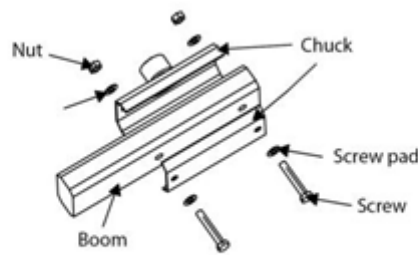
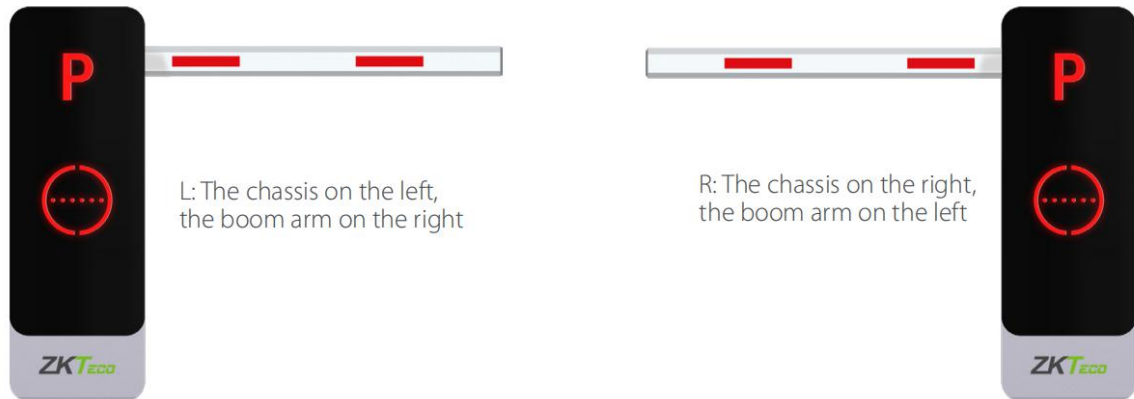

Figure 2 Install the Boom to the Chassis

#### Note:

1. Before the barrier is powered on to run the test process, be sure to install the barrier boom of the corresponding length for the test. If the barrier boom is not installed, please adjust and remove the spring under the guidance of a professional.
2. If the length of the barrier boom is cut and adjusted, the tightness of the spring and the position of the hanging hole need to be adjusted accordingly to avoid the abnormal working status that cannot drop the boom.

## 6 Left and Right Directions



## 7 Mainboard Wiring Instructions

1. Please disconnect the power supply before wiring.
2. **To switch the input voltage to 110V, please note that you need to set the DIP switch as shown in the below image:**

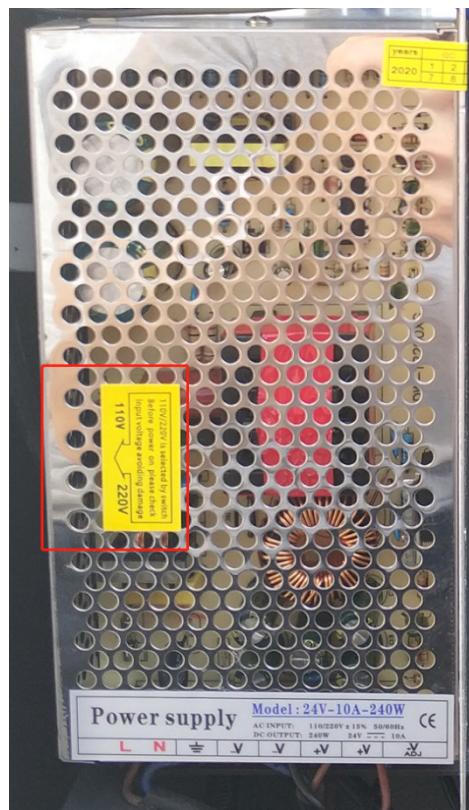

3. Check carefully whether the terminals are tightened and whether the wiring is firm.
4. The wiring diagram of the control panel is given below:

### BG1000 Wiring Diagram of Mainboard

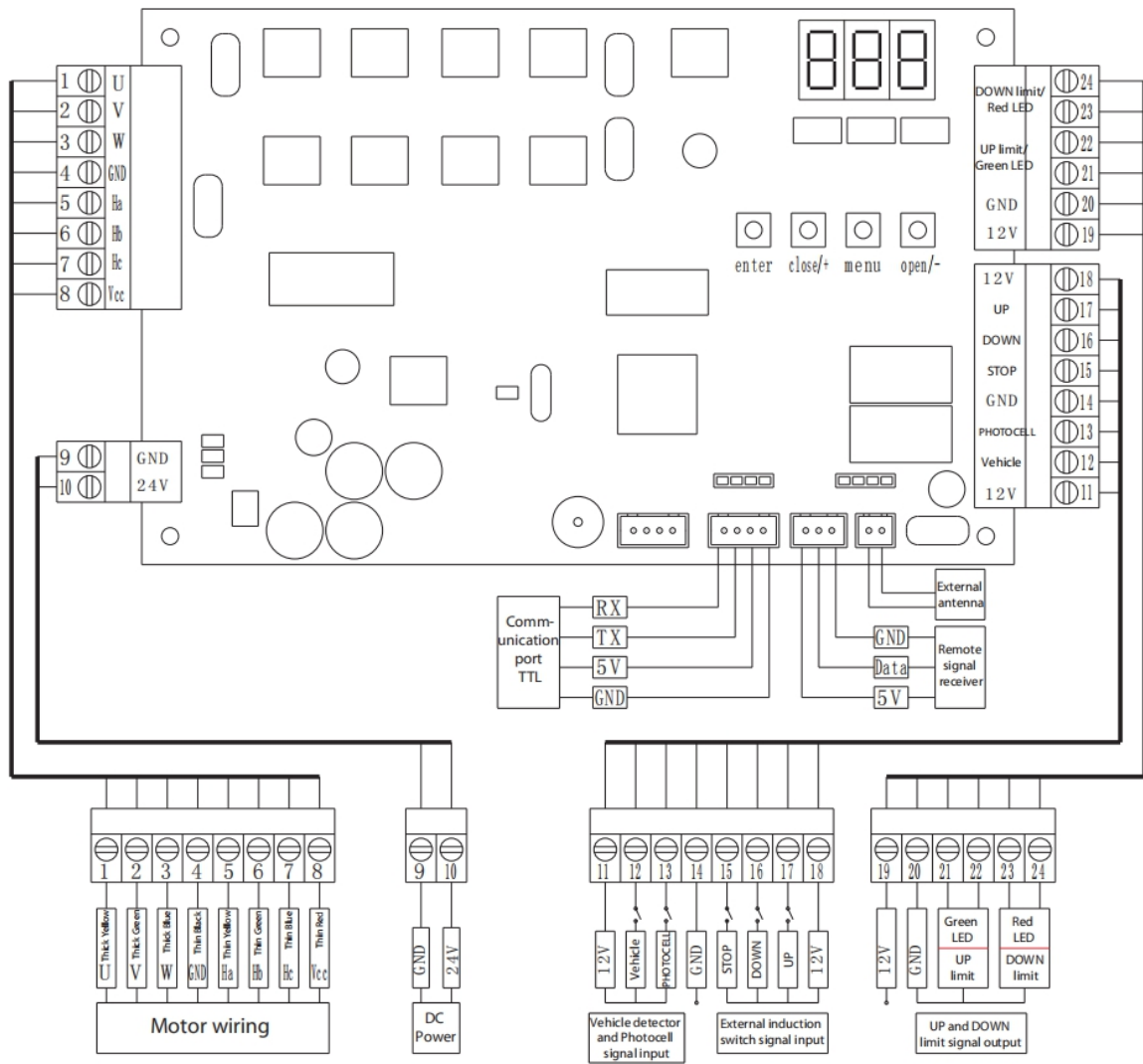

## 7.1 Connection with LPR Camera

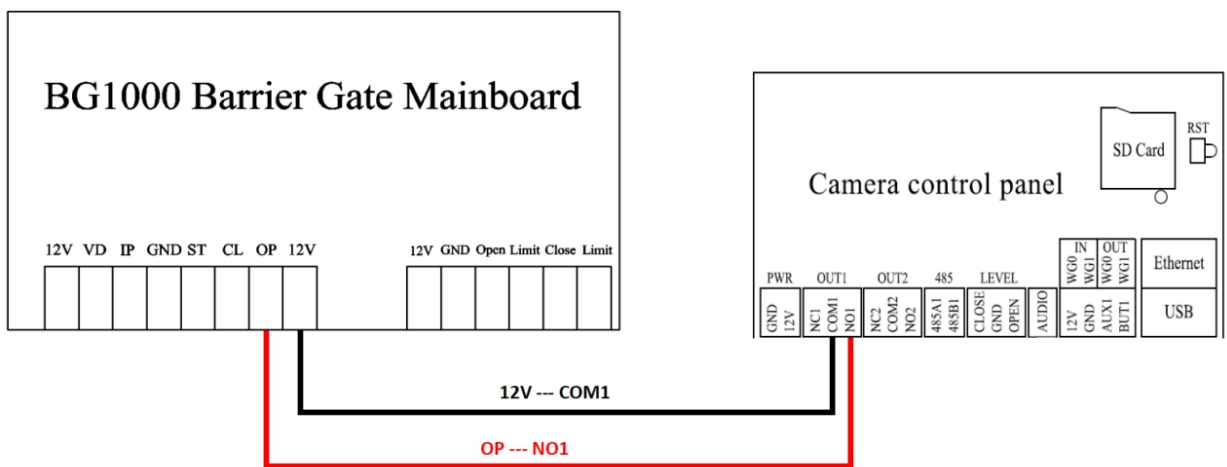

## 7.2 Connection with UHF Controller

**(Note:** The Reader1 and 2 of Inbio260 Controller corresponds to LOCK1, Reader3 and 4 corresponds to LOCK2)

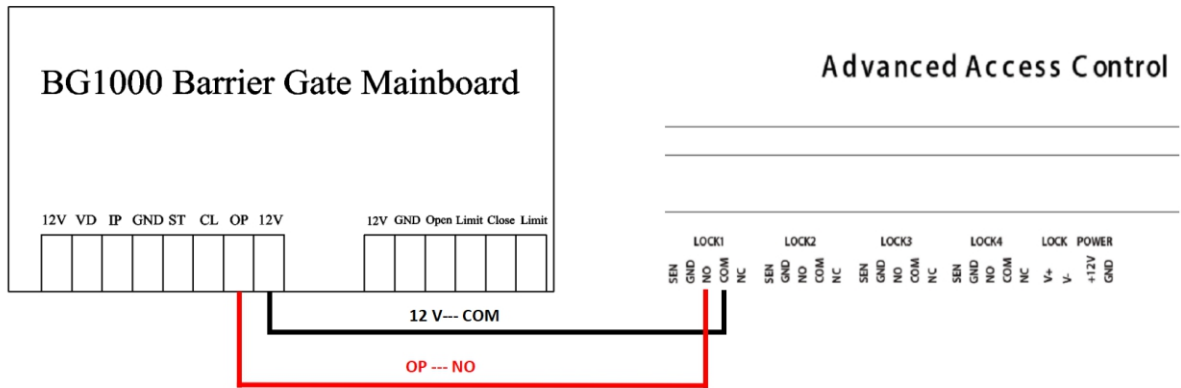

## 7.3 Connection with Loop Detector

**Anti-smash and Auto-close function**

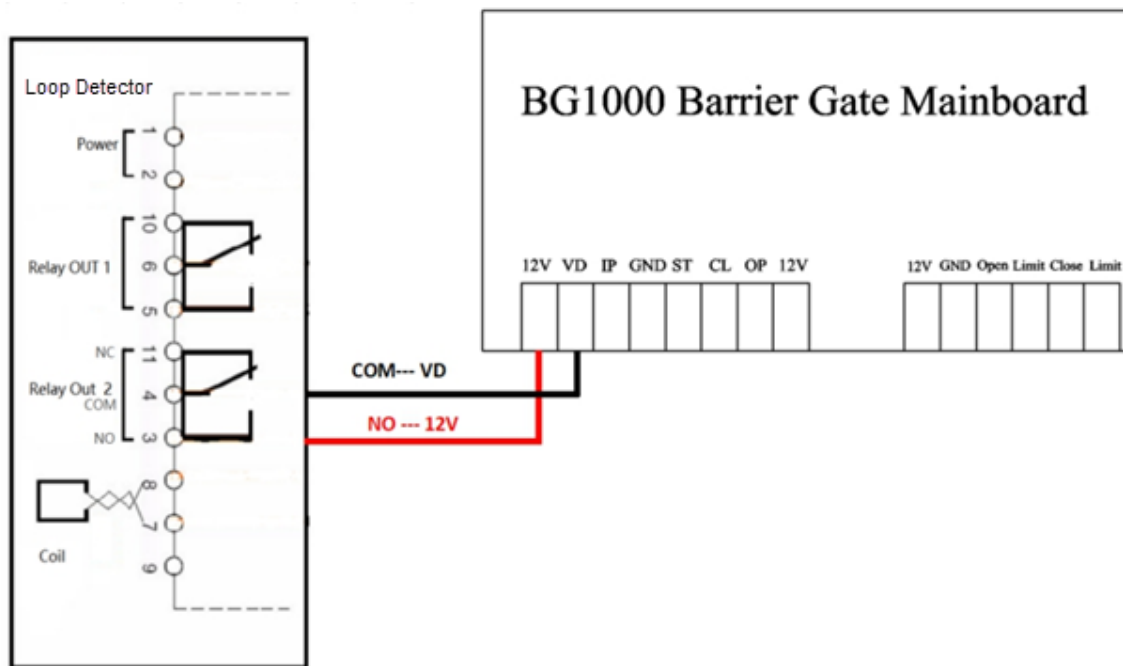



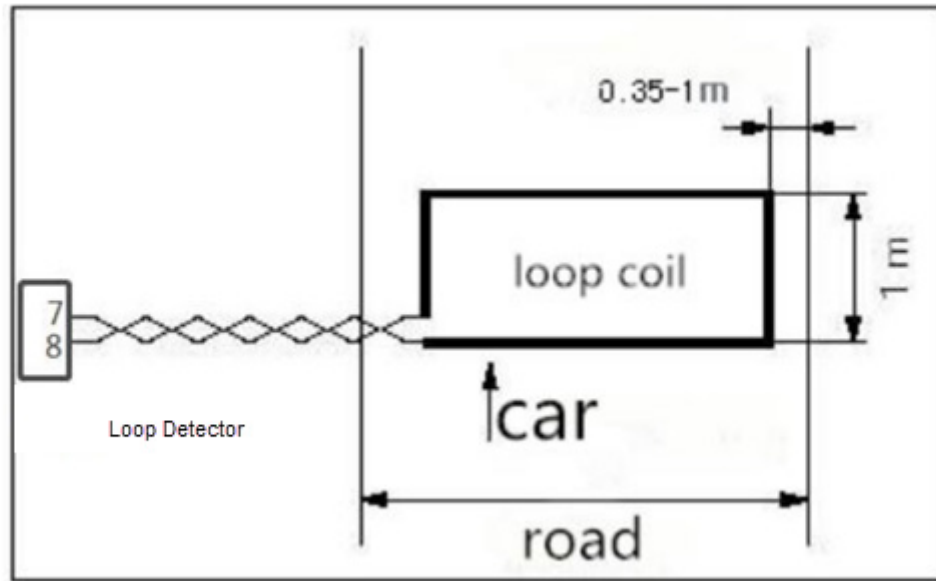

Coil Circumference	Coil Number
3m	Based on requirements, ensure that the inductance is between 100μH and 200μH
3m to 6m	5 to 6 turns
6m to 10m	4 to 5 turns
10m to 25m	3 turns
25m	2 turns

### 7.4 Connection with VR10 Radar Sensor

#### Anti-smash and Auto-close function

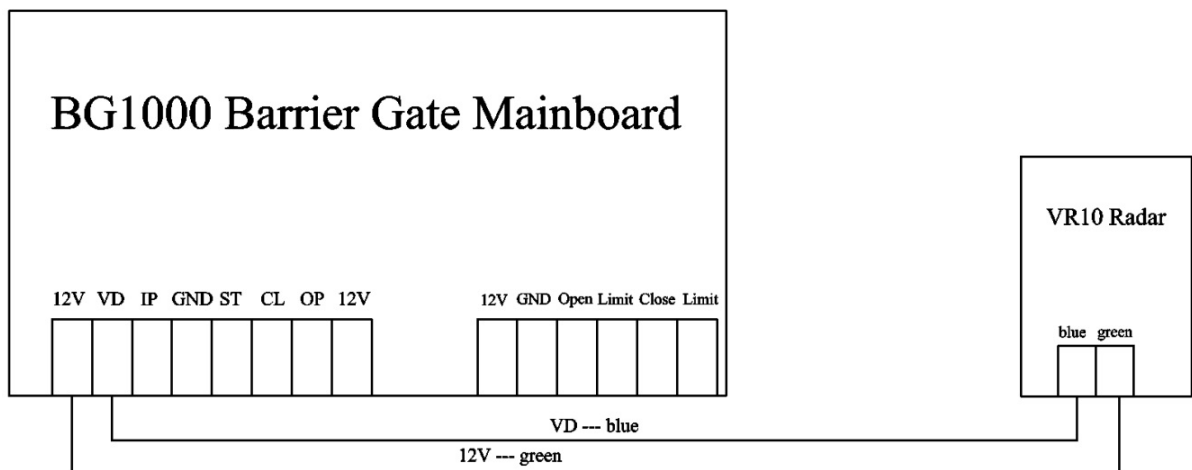

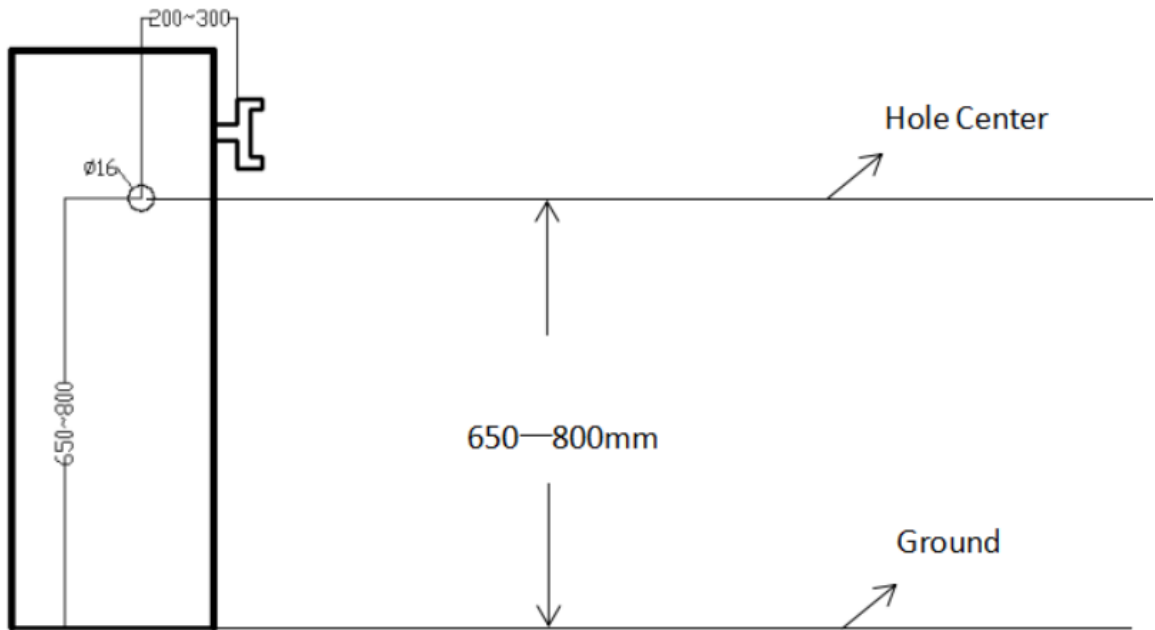

## 7.5 Connection with Infrared/Photocell Detector

### Anti-smash function

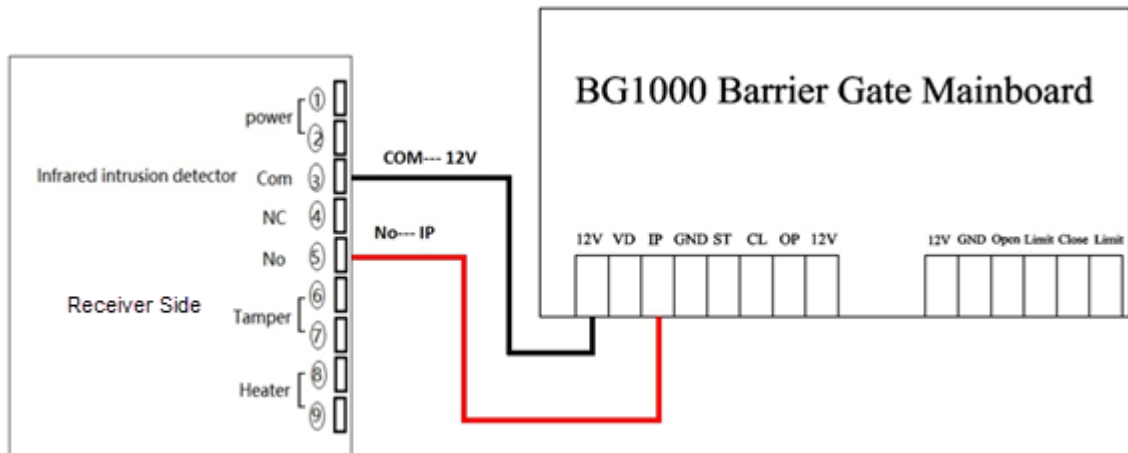

### Anti-smash and Auto-close function

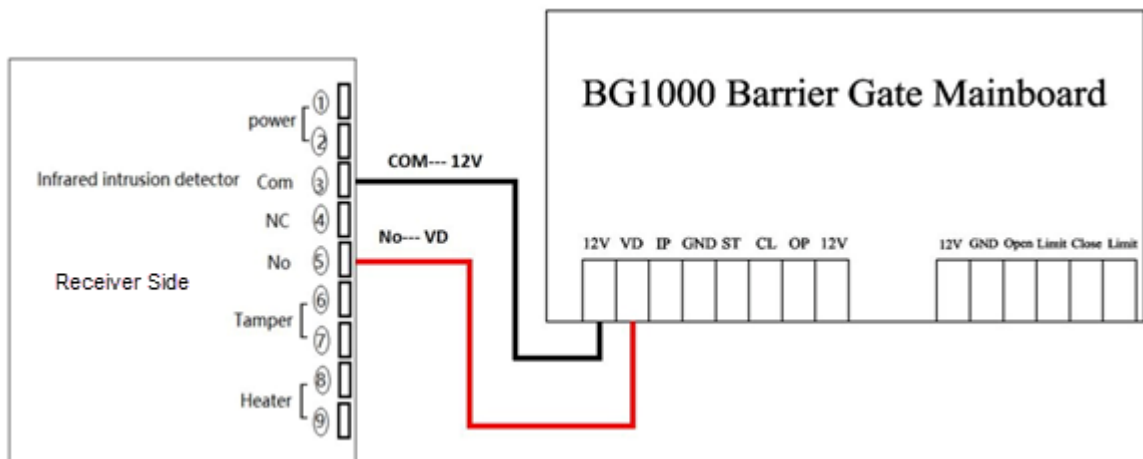

#### ◆ Mounting height

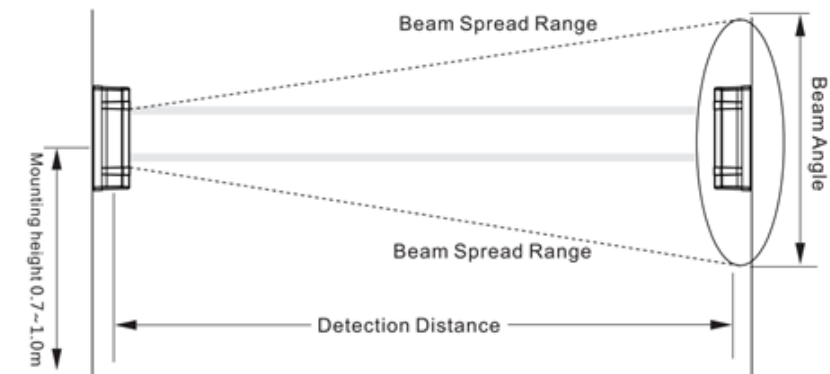

#### ◆ Adjusting angle

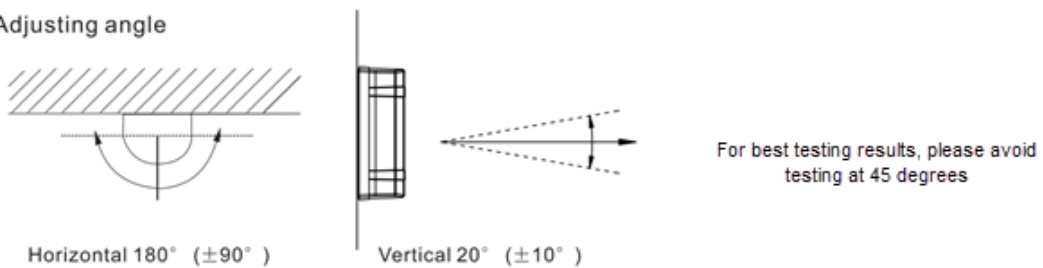

## 8 Functional Parameter Settings

After the initial installation, and first power-on, you must use the "on" and "off" buttons on the mainboard to complete the self-check process and learn the opening and closing strokes.

### 8.1 Mainboard Parameter Settings

#### Key Description

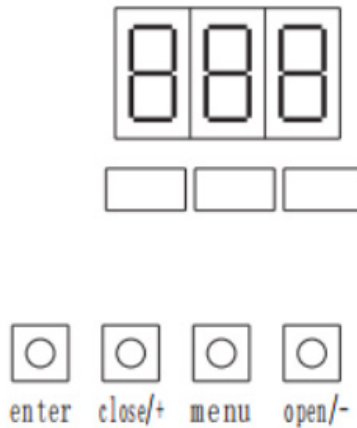

**Menu:** Menu options / Confirm and Enter

**Enter:** Confirm and Exit

**Open/-:** Decrease parameter/value

**Close/+:** Increase parameter/value

#### 8.1.1 Operating Procedure

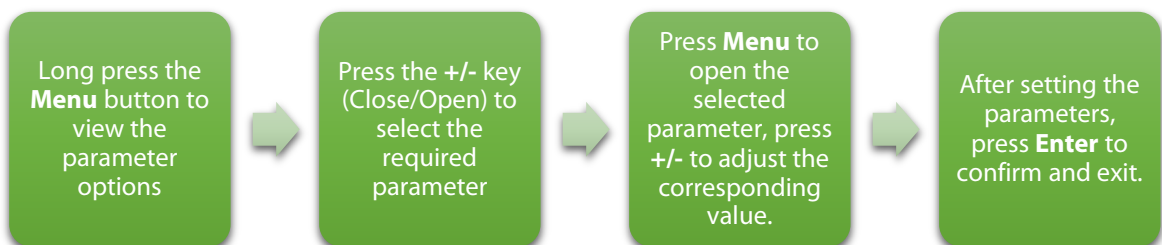

The display status is given below:

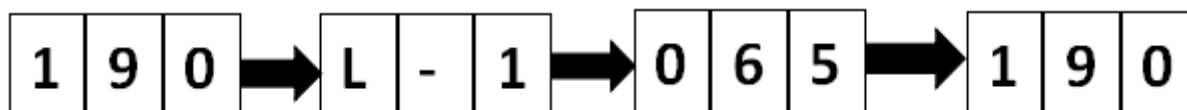

## 8.2 Parameter Settings Description

Parameter	Description	Menu List	3m Boom	4.5m Boom	6m Boom
Gate Opening Speed Adjustment	The larger the value, the faster the opening speed	L-1	90	70	60
Gate Closing Speed Adjustment	The larger the value, the faster the gate closing speed	L-2	85	65	55
Barrier Boom balance Adjustment	Default	L-3	12	12	12
Anti-smashing Car Response Time Sensitivity Adjustment	The shorter the reaction time, the higher the sensitivity.	L-4	30	30	30
Motor Strength Adjustment	Default	L-5	70	70	70
Horizontal Boom Barrier Adjustment	-	L-6	5	5	8
Test Mode Selection	0 – Manual 1 - Automatic (default)	L-7	0	0	0
Turn on Memory function	0 – No Memory 1 - Memory 4 - Peak mode(default)	L-8	0	0	0
Vertical Boom Barrier Adjustment	-	L-9	5	5	8
Deceleration stroke adjustment of the first stage of opening brake	-	L-L	45	65	40
Deceleration stroke adjustment of the second stage of closing brake	-	L-B	55	55	40
Anti-Smashing Vehicle Strength Adjustment	The larger the value, the more severe the damage to the object.	L-C	50	50	50
Forward and Reverse operation setting of the barrier	Type 1 - L Type 2 – R (Factory setting)	L-D	1 or 2	1 or 2	1 or 2
Motor force when the barrier is activated	Torque output by the motor when the	L-E	30	30	30

	barrier is activated.				
Remote learning function	000 - Learning State 253 - Automatic deletion of the remote control	L-F	0	0	0
Deceleration stroke adjustment for the first section of the opening gate	Default	L-H	0	0	0
Deceleration stroke adjustment of the second section of the closing gate	Default	L-P	21	21	21
Traffic Light Mode Adjustment	Default	L18	0	0	0
Ground Sensing Delay to drop the boom	0 - Disabled 1 - 255 is the time corresponding to the delay (need to synchronize with the ground sensing system)	L19	0	0	0
Automatic boom-dropping delay after starting	0 - Disabled 1 - 255 is the time corresponding to the delay in automatic boom-dropping	L20	0	0	0

### 8.3 Remote Control Pairing and Unpairing

- Remote Control Pairing:** Long press **Menu**, then press +/- to select L-F [L15]. Press **Menu** again to set the parameter value. At this time, the LED display value is "000", and then press any button on the remote control until you hear a beep sound from the Mainboard. If it automatically returns to the menu option, it means the pairing is successful, and then press **Enter** to exit the menu.

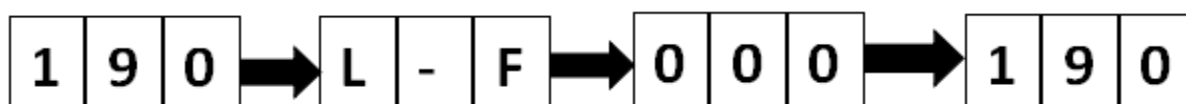

- Delete Remote Control Pairing:** Long press **Menu**, then press +/- to select L-F [L15]. Press **Menu** again to set the parameter value, and then set the parameter value to "253". At this time, it will automatically return to the menu, indicating that all the remote controls have been deleted.

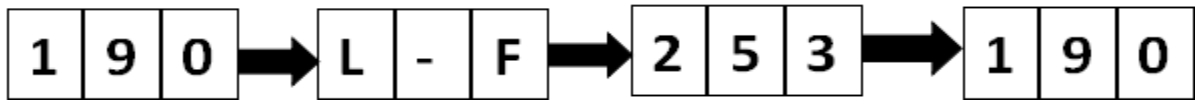

## 8.4 Set Delay for Automatic Closing after Opening

### the Boom

Long press the **Menu** button, then press +/- to select the L20 parameter, and then press the **Menu** to set the parameter value after selection. At this time, the display will be 000 i.e., in the disabled state. Set the delay value as per the requirements. Finally, press **Enter** to exit the menu. For example, if it is set to "005", the machine will automatically close after 5 seconds after opening the barrier.

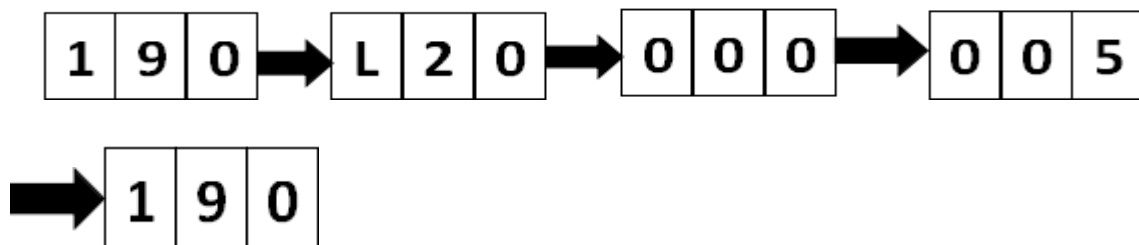

## 9 Boom Barrier Adjustments

### 9.1 Dimensions

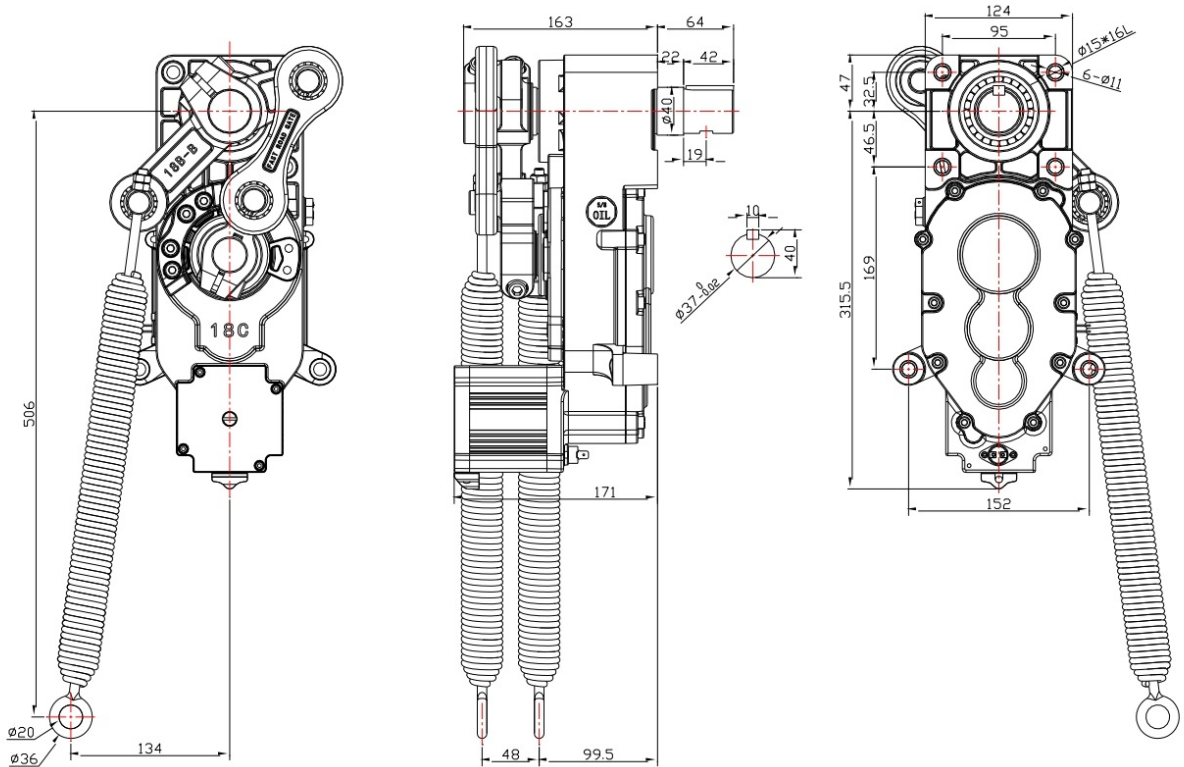

### 9.2 Horizontal and Vertical Angle Adjustment of Barrier Boom (Mechanical Adjustment)

**Note:** The horizontal and vertical angles of the barrier boom have been adjusted before leaving the factory. Please do not adjust them without the guidance of professionals to avoid mechanical damage.

#### 1. Adjust the horizontal position of the barrier boom

The connecting boom crank will be an overlapping structure, and the two rotation points of the connecting boom are coincident with the output shaft of the reducer at 3 points and a line. This is the horizontal position of the barrier boom. If you find that the barrier boom is not in level or inclined at this time, then loosen the 2 screws of the rocker (rocker-arm), turn the barrier boom to the level, and tighten the screws.



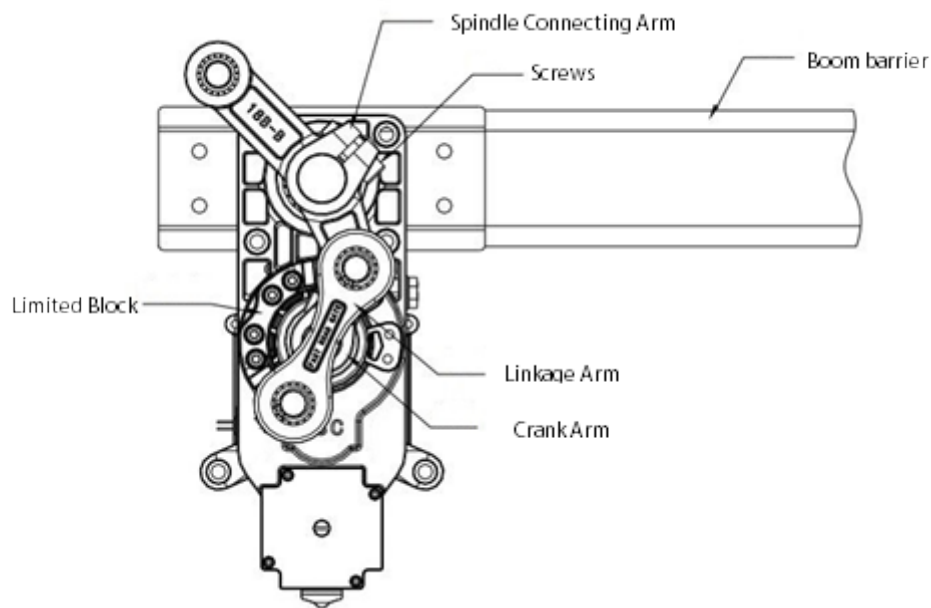

## 2. Adjust the vertical position of the barrier boom (adjusted by mechanical structure)

The connecting boom crank is in an unfolded shape, and the two rotation points of the connecting boom and the output shaft of the reducer are in an unfolded 3-point line. This is the vertical position of the barrier boom. If it is found that the barrier boom is not in the vertical position and is inclined at this time, then loosen the 2 screws of the rocker (rocker-arm), turn the barrier boom to the vertical, and tighten the screws.

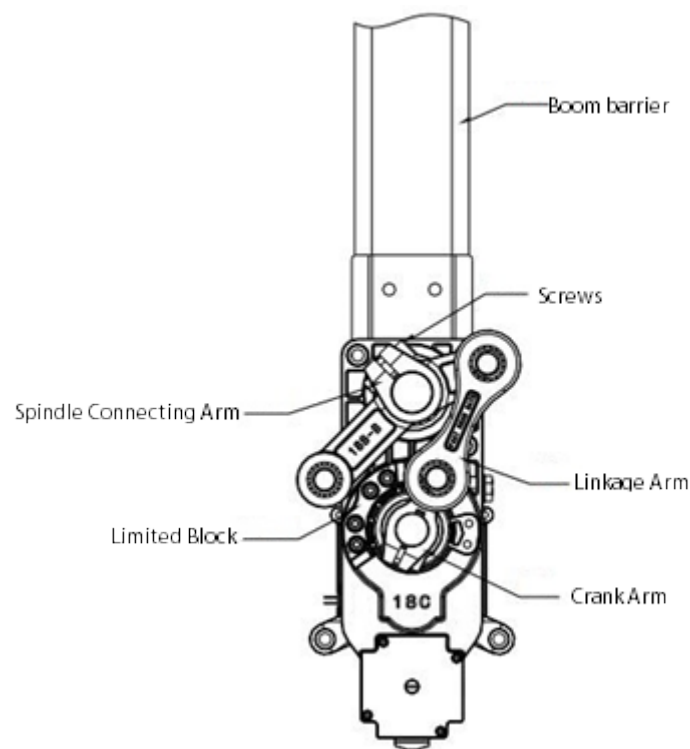

### 9.3 Direction Interchange of the Barrier Boom

For example, when L is changed to R, the operation steps are as follows:

Step 1: With the barrier boom is in a vertical state, turn off the power, and then remove the spring, as shown in the figure.

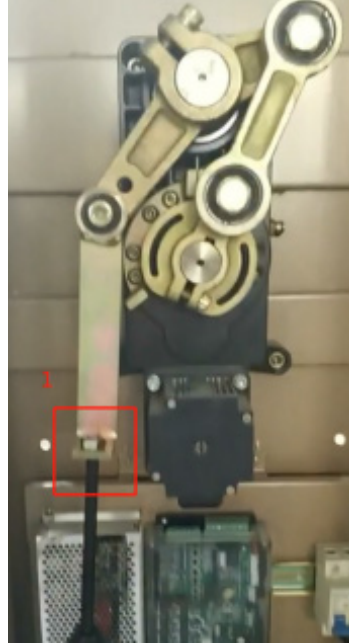

Step 2: Use a socket wrench to remove the linkage arm. Unscrew the screws at both the ends, loosen the linkage arm (washer behind the screws must be safe), as shown in the figure:



Step 3: Remove the spring connecting arm (washer behind the screw must be safe), as shown in the figure:

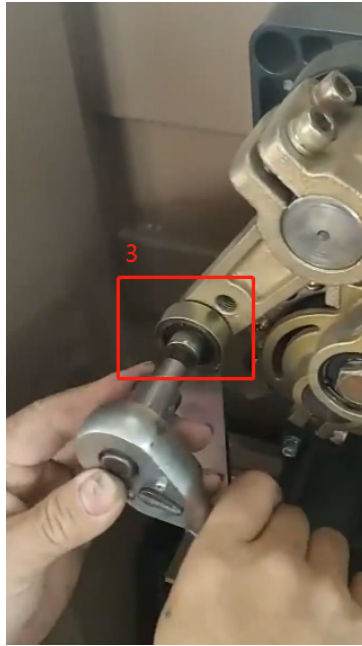

Step 4: Loosen the 2 screws on the spindle connecting arm and take out the rocker arm, as shown in the figure:

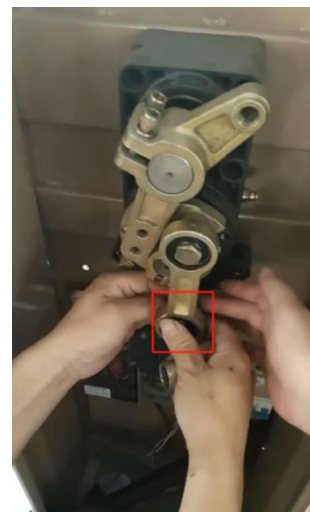

Step 5: Take out the spindle connecting arm and place it in another direction (key, L→R), as shown in the figure:

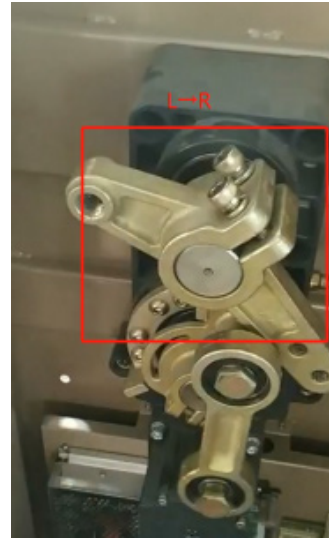

Step 6: Remove the 4 screws on the mechanical limited block, move the limit block to the right symmetrical position, and then tighten the screws:



Step 7: Connect the linkage arm to the spindle connecting arm and install it (gasket at the back of the screw must be safe), as shown in the figure:



Step 8: Connect and install the spring connecting arm with the spindle connecting arm (gasket on the back of the screw must be safe), as shown in the figure:

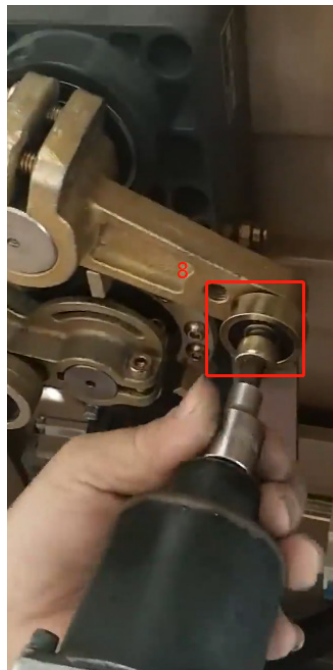

Step 9: Replace the spring to the right, then connect it to the spring connecting arm and install it, as shown in the figure:

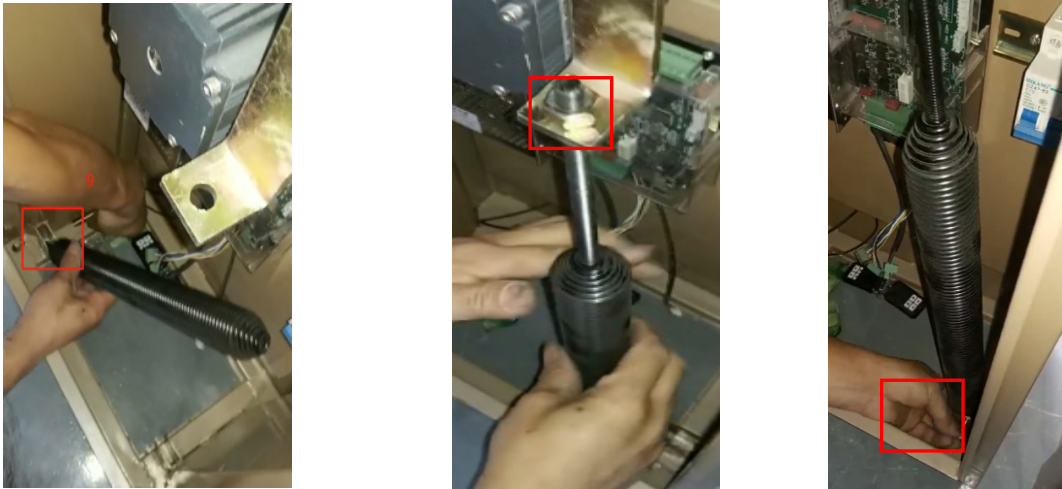

Step 10: After adjusting the vertical and parallel angles of the barrier boom, finally tighten the two screws of the spindle connecting arm, as shown in the figure:

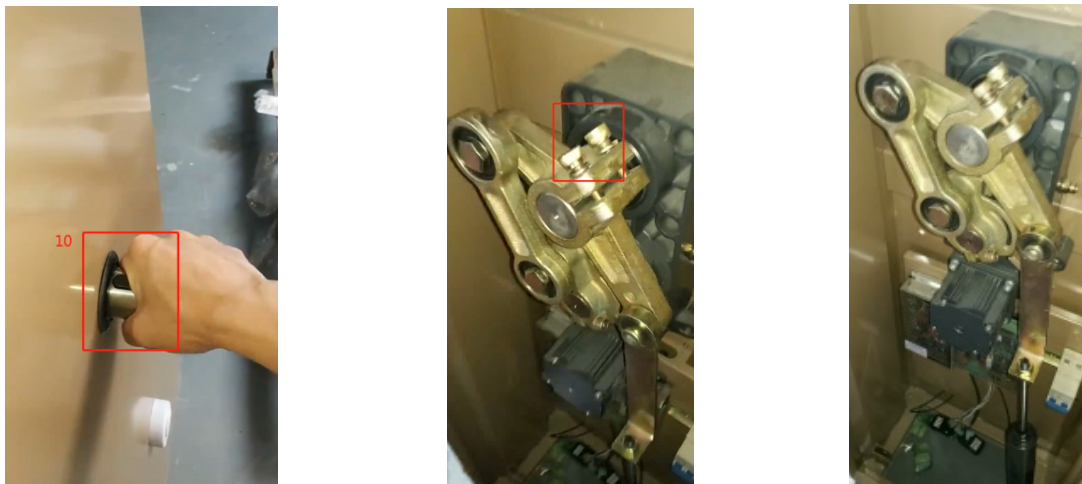

Step 11: Finally, set the L-D parameter on the control panel to "2" (note that L is "1" and R is "2").

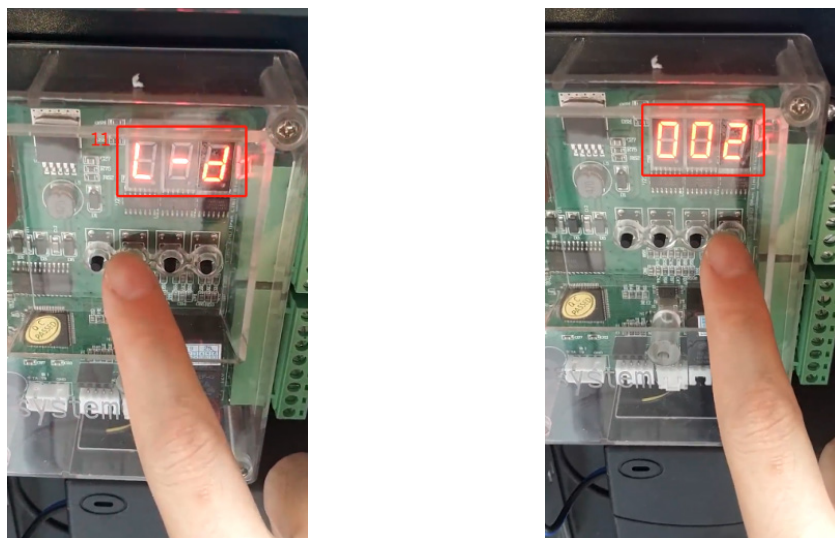

## 9.4 Spring Adjustment

The higher the spring screw (blue box), the tighter the spring and the greater the tension. The lower the spring screw (blue box), the looser the spring, and the lesser the tension.

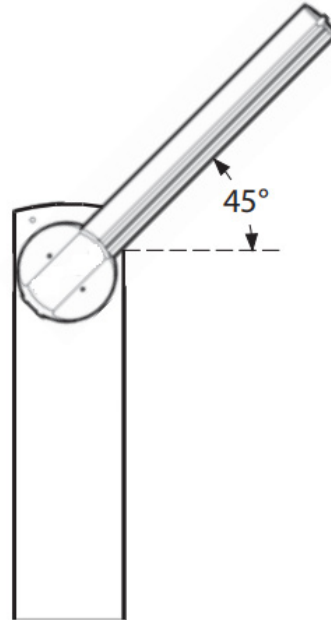
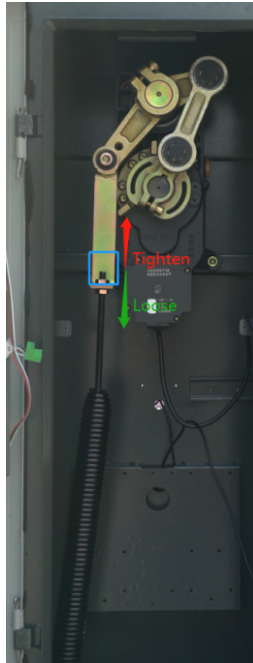

### Notes:

1. When the barrier boom is at 45°, it is the best balance.
2. The spring wire diameter is adapted to different boom lengths: 3m boom with  $\phi 4.5\text{mm}$ ; 4.5m boom with  $\phi 5.5\text{mm}$ ; 6m boom with  $\phi 6.5\text{mm}$ . (If the boom is too short i.e., less than 2m, do not install the spring).

## 10 Product Packing List

Material	Quantity
<b>Chassis Explosion Screw M12X140</b>	4
<b>Keys</b>	2
<b>Barrier Boom</b>	1
<b>Boom Pressure Plate</b>	1
<b>Chassis Pressure Plate</b>	2
<b>Wireless Remote</b>	2
<b>Barrier Boom hexagon bolt M10X70</b>	2
<b>Machine</b>	1
<b>User manual</b>	1



## 11 Troubleshooting

- ❖ **Description: The Power Supply has a 24V output, but the mainboard power indicator does not light up.**

### Cause

1. 24V output wiring might be reversed
2. The mainboard might work abnormally
3. Loose wiring

### Solution

1. Swap the DC output wiring
2. Replace the Mainboard
3. Tighten the wiring

- ❖ **Description: The AC input is normal, but the power indicator is off.**

### Cause

1. The power fuse might be blown
2. Abnormal power supply
3. Loose wiring

### Solution

1. Replace the fuse
2. Replace the power supply
3. Tighten the wiring

- ❖ **Description: The power indicator is on, the landing boom indicator is normal, and the motor is not running.**

### Cause

1. The motor wiring might be wrongly connected, or the wiring is loose
2. The internal encoder of the motor may work abnormally
3. The motor stroke limit exceeds the position

### Solution

1. Check the wiring according to the wiring diagram, and tighten the wiring if required
2. Replace the motor
3. Re-adjust the motor limit parameters

- ❖ **Description: The remote-control buttons do not respond.**

### Cause:

1. The remote-control battery is completely discharged
2. There must be a signal interference with the same frequency
3. There may be obstacles nearby
4. The remote-control frequency is not matched, or the receiver is damaged

### Solution:

1. Replace the battery
2. Use manual button control

3. Use in open areas
4. Replace the remote control to re-match or replace the receiver

❖ **Description: When the gate is closed halfway, it bounces back to the open state.**

**Cause:**

1. The barrier boom might not be installed
2. The spring is too tight, or the length of the barrier boom is changed, and the spring is not properly adjusted

**Solution:**

1. Install the barrier boom
2. Adjust the spring according to the length of the barrier boom

## 12 Safety Precautions

- It is strictly forbidden to hit the product with hard objects.
- When using, please handle with care to avoid strong collision with hard objects.
- Do not spill water or corrosive liquids on the surface of the product.
- If smoke or a peculiar smell comes from the product, disconnect the power immediately.
- If the product works abnormally, please contact the dealer in time. Please do not try to repair it by yourself. If you handle it without authorization, the company is not responsible for any damage.

## 13 Transportation and Storage

- When loading and unloading the product, handle it with care.
- During transportation and storage, place it in a dry and corrosive-free environment. The product should be protected from moisture, rain, sun, and corrosion.

## 14 Warranty

This product promises a warranty period of 2 years. Upon normal use of the product, damages are covered by the warranty. However, damages caused by the following conditions are not covered by the warranty.

- Damages caused by incorrect operation and violation of operating procedures.
- Damages caused by repairing the product without authorization.
- Abnormalities and damages caused by extremely harsh operating conditions and operating environment beyond the machine's ability to withstand.
- Damages caused by irresistible factors (such as earthquake, tsunami, typhoon).

ZKTeco Industrial Park, No. 32, Industrial Road,

Tangxia Town, Dongguan, China.

Phone : +86 769 - 82109991

Fax : +86 755 - 89602394

[www.zkteco.com](http://www.zkteco.com)



Copyright © 2021 ZKTECO CO., LTD. All Rights Reserved.